



Graco® Supply Systems

Sealant and Adhesive Supply Systems with NXT™ Technology



PROVEN QUALITY. LEADING TECHNOLOGY.

Graco Supply Systems with NXT Technology

Discover the next generation of bulk supply systems

Graco Supply Systems reliably deliver one-component sealants, adhesives and other medium to high-viscosity materials from pails or drums to metering and dispensing systems. Designed with innovative features plus advanced pump and air motor technologies, Graco Supply Systems help maximize your plant's production capacity.

Easy to Service

- Smart design and simple features reduce time spent on maintenance

NXT Air Motor

The next generation of Graco air motors

- Long-lasting and durable
- Modular air valve eliminates stalling

Check-Mate® or Dura-Flo™ Pump

- Cartridge design makes packings easy to replace

Integrated Drum Air Blow-Off

- Reduces downtime with quick, easy drum changes

Tandem Control

- Improve productivity by operating two supply systems in tandem



DataTrak™ Control

- Tracks material usage and flow
- Provides pump runaway protection

Integrated Air Controls

- Conveniently located - easy to see, easy to use

Platen Design

- Minimizes leftover material and reduces waste
- Long-lasting, one-piece platen seals are easy to replace



Graco D60 Supply System

Designed to Reduce Your Cost of Ownership



Features that reduce your cost of ownership:

- Optional MaxLife® coatings and seals triple the life of the standard offering
- Durable NXT Air Motor lasts ten times longer than its predecessor
- Common and shared parts throughout rams and air motors provide low carrying costs, even when multiple configurations are used within a plant
- Electric tandem systems significantly reduce downtime with advanced monitoring and control systems

Features that make Graco Supply Systems easy to use:

- Quick placement of drum or pail
- Integrated air controls offer easy-to-see, easy-to-use controls
- Intuitive user interface
- Platen wipers can be replaced in seconds
- Pump's quick-disconnect coupler, turnbuckle mount and pump cartridge packings let you service the pump without removing it from the ram
- Optional sensors and light tower let operator know when it's time to change the drum
- Optional electric tandem filter monitoring and electric depressurization allow complete control over the tandem system

Minimize maintenance and streamline operations

Because Graco Supply Systems are engineered and built with high-quality parts, you reduce maintenance time, maximize uptime, and benefit from longer equipment life.

A complete line of Graco Supply Systems



L20c

Lightweight, elevator ram on a cart. For low-volume applications of low-viscosity materials that do not require extra pressure. Air controls raise pump up, gravity forces platen down. Easy-to-move cart for added mobility. Ideal for construction sites.



S20

For low-volume in-plant applications of medium to high-viscosity materials. May be used as a feed package in more complex systems.



S20c

Offers the same features and benefits as the S20, but includes a cart for added mobility.



D60

For medium to high-viscosity materials. Provides higher down-force and larger pail capacity than the S20.



D200

For high-volume in-plant applications of medium to high-viscosity materials.



D200s

For heavy-duty, high-volume applications of high-viscosity materials. Larger 6.5-in ram posts provide more down-force for difficult-to-move materials.

A Full Line of Supply Systems



Technical specifications

MODELS	L20C	S20	S20C
Platens	20 L (5 gal) Wiper Seals Polyurethane, PTFE, Nitrile	20L (5 gal) Wiper Seals Polyurethane, PTFE, Nitrile	20L (5 gal) Wiper Seals Polyurethane, PTFE, Nitrile
Check-Mate Pumps	C5 / C11 / C20 / C38 / C61	C5 / C11 / C20 / C23 / C36 C38 / C40 / C61 / C63	C5 / C11 / C20 / C23 / C36 C38 / C40 / C61 / C63
Dura-Flo Pumps	Not available	Not available	Not available
DataTrak Control	Not available	Not available	Not available
Tandem Display	Not available	Pneumatic	Not available
Operation Manual	313526	313526	313526
Operation Manual Tandem	Not available	313528	Not available
Repair Manual	313527	313527	313527
Repair Manual Tandem	Not available	313529	Not available

Technical specifications

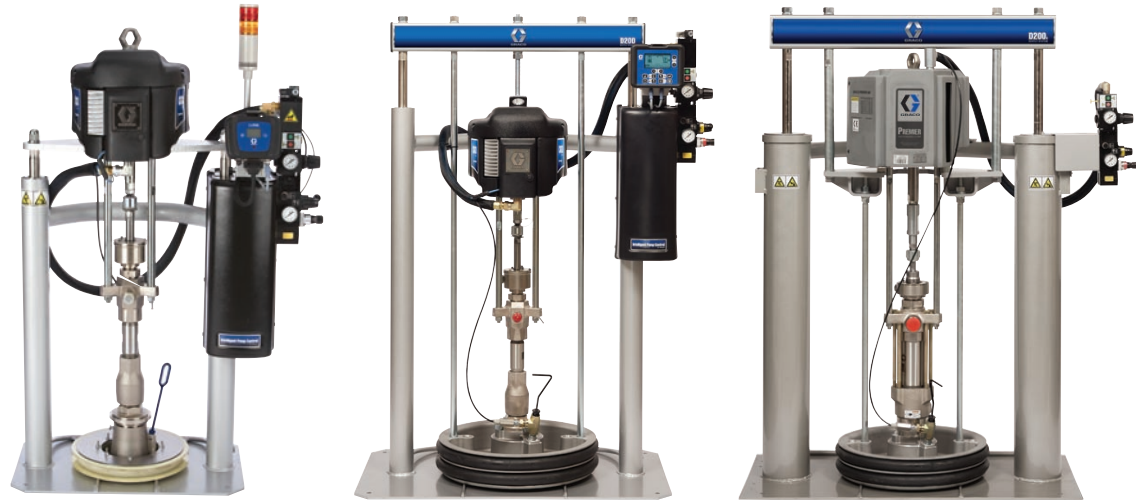

MODELS	D60 AND D60i			D200 and D200i					D200s and D200si	
Platens	20 L (5 gal)	30L (7 gal)	60 L (16 gal)	20L (5 gal)	30 L (7 gal)	60 L (16 gal)	114 L (30 gal)	200 L (55 gal)	30L (5 gal)	20 L (5 gal)
	Wiper Seals Polyurethane, PTFE, Nitrile	Wiper Seals Polyurethane, PTFE, Nitrile	Wiper Seals Polyurethane, PTFE, Nitrile	Wiper Seals Polyurethane, PTFE, Nitrile	Wiper Seals Polyurethane, PTFE, Nitrile	Wiper Seals Polyurethane, PTFE, Nitrile	Wiper Seals Polyurethane, PTFE, Nitrile	Wiper Seals Polyurethane, PTFE, Nitrile	Wiper Seals Polyurethane, PTFE, Nitrile	Wiper Seals Polyurethane, PTFE, Nitrile
Check-Mate Pumps	C23 C29 C36 C40 C55 C63 C68	C23 C29 C36 C40 C55 C63 C68	C23 C29 C36 C40 C55 C63 C68	C5 C11 C20 C23 C29 C36 C38 C40 C55 C61 C63 C68	C5 C11 C20 C23 C29 C36 C38 C40 C55 C61 C63 C68	C5 C11 C20 C23 C29 C36 C38 C40 C55 C61 C63 C68	C5 C11 C20 C23 C29 C36 C38 C40 C55 C61 C63 C68	C5 C11 C20 C23 C29 C36 C38 C40 C55 C61 C63 C68	C23 C29 C36 C40 C55 C63 C68	C23 C29 C36 C40 C55 C63 C68 C82 C14 C26 C39
Dura-Flo Pumps	D30 D31 D46 D57	D30 D57			D30 D57		D31 D46	D12 D15 D22 D30 D31 D32 D40 D45 D46 D57		D34 D44 D67
DataTrak Control	Available			Available					Available	
Tandem Display	Available			Available					Available	
Operation Manual	313526			313526					313526	
Op. Man. Tandem	313528			313528					313528	
Repair Manual	313527			313527					313527	
Rep. Man. Tandem	313529			313529					313529	

Advanced Controls – The Rules Have Changed

Advanced, intuitive controls

The electronic controls on Graco Supply Systems help you monitor and control critical factors through an easy-to-use interface.



Tandem Display Module. Improved efficiency and control.

The Tandem Display Module allows you to configure your supply systems to operate in tandem for better productivity and improved uptime.

- Automatic electric crossover eliminates downtime – you get double the material volume before you need to change drums or pails
- Easy user interface puts the operator in total control
- Only one Tandem Display Module needed for two systems

DataTrak Control. More control than ever.

Graco Supply Systems are available with DataTrak, an “intelligent” integrated electronic monitoring system. DataTrak puts you in control by:

- Tracking and displaying material usage and volumetric flow, telling you how much material is left in the drum
- Providing pump diagnostics, indicating when it's time for routine maintenance
- Providing pump runaway protection by monitoring pump speed and automatically shutting off the pump





Fluid Control Module

Graco's user display and fluid control module allow you to monitor and control critical process variables including:

- Electronic control of depressurization and recirculation
- Optional filter pressure tracking and monitoring to warn of potential rips or plugs

Integrated Air Controls

- Modular design
- One convenient, easy-to-use location
- One-touch blow-off provides easy drum replacement
- Optional two-button interlock

Platen and Wiper Options

A modular approach gives you added flexibility

Graco platens are designed with a modular approach. You can easily interchange platen components if you need to switch pail sizes or materials. Choose flat or dual flat wipers for 20, 30 or 60-liter pail sizes or o-ring wiper style for 200-liter drums.



Platen with flat single wiper



Platen with flat dual wiper

Platen ordering information

Assembled Platens (single wiper)

257727	20 l (5-gal) Nitrile
257728	20 l (5-gal) Polyurethane
257729	20 l (5-gal) PTFE
257732	30 l (7-gal) Nitrile
257733	30 l (7-gal) Polyurethane
257734	30 l (7-gal) PTFE
257737	60 l (16-gal) Nitrile
257740	60 l (16-gal) Polyurethane
257738	60 l (16-gal) PTFE

Assembled Platens (dual wiper)

257730	20 l (5-gal) Nitrile
257731	20 l (5-gal) Polyurethane
257735	30 l (7-gal) Nitrile
257736	30 l (7-gal) Polyurethane
257739	60 l (16-gal) Nitrile
257741	60 l (16-gal) Polyurethane
255661	114 l (30-gal) EPDM
255664	200 l (55-gal) Neoprene
255663	200 l (55-gal) EPDM
255662	200 l (55-gal) EPDM with PTFE-coated platen

Replacement Kits (single wiper)

257639	20 l (5-gal) Nitrile
257640	20 l (5-gal) Polyurethane
257641	20 l (5-gal) PTFE
257644	30 l (7-gal) Nitrile
257645	30 l (7-gal) Polyurethane
257646	30 l (7-gal) PTFE
257649	60 l (16-gal) Nitrile
257650	60 l (16-gal) Polyurethane
257651	60 l (16-gal) PTFE

Replacement Kits (dual wiper)

257642	20 l (5-gal) Nitrile
257643	20 l (5-gal) Polyurethane
257647	30 l (7-gal) Nitrile
257648	30 l (7-gal) Polyurethane
257652	60 l (16-gal) Nitrile
257653	60 l (16-gal) Polyurethane
255654	114 l (30-gal) EPDM
255652	200 l (55-gal) Neoprene
255653	200 l (55-gal) EPDM
255653	200 l (55-gal) EPDM with PTFE-coated platen

Graco Supply Systems with NXT Technology

NXT Air Motor – the next generation of Graco air motors

The NXT Air Motor provides long-lasting durability. In fact, the NXT Air Motor is proven to last 10 times longer than its predecessor, the Graco King®.

- Low air consumption for increased efficiency
- External valve access allows for easy servicing and online replacement to minimize downtime
- Patented exhaust manifold reduces noise and icing – up to 50% quieter than previous models

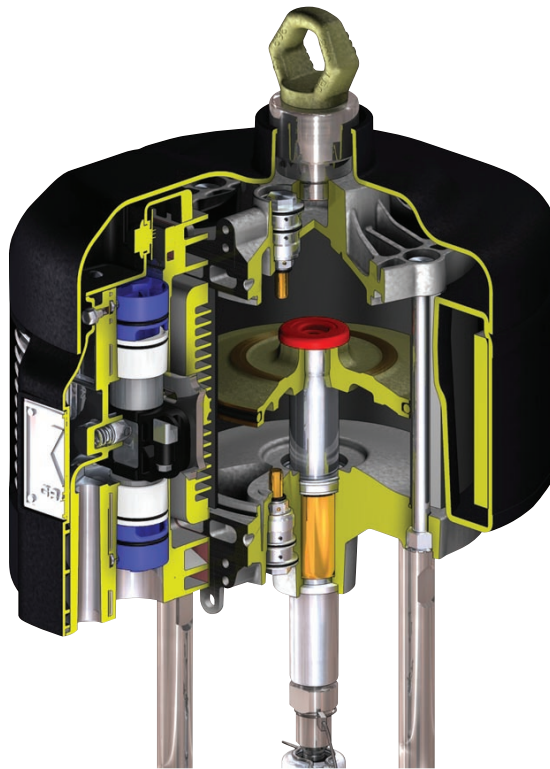

New small NXT Air Motors

Graco's line-up of smaller rams including the L20c, S20 and S20c, are available with smaller-size diameters.

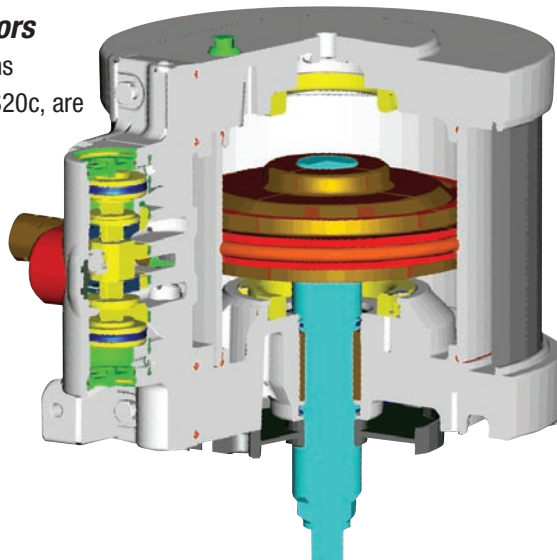

NXT Technology: Less pulsation for better results

NXT Air Motor technology provides a smooth, rapid changeover for a more consistent bead and less downtime.

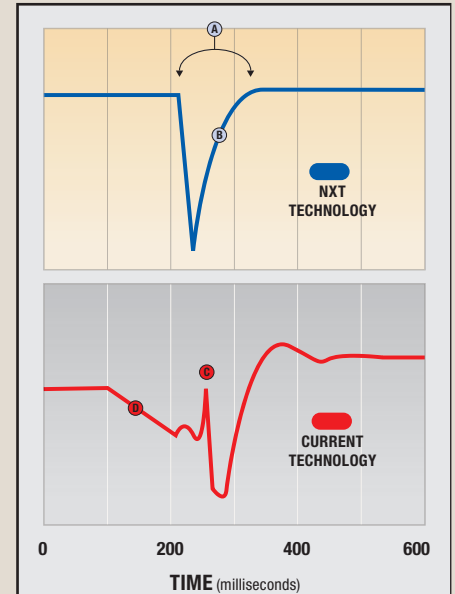

- (A) Less than $\frac{1}{15}$ of a second changeover!
- (B) Quick changeover and recovery with less pulsation
- (C) Pressure spike at changeover
- (D) Longer changeover causing pulsation

Noise-reduction technology

The quiet, low-noise NXT Air Motor operates around 87 decibels, while other comparable motors operate up to 103 dB(A).

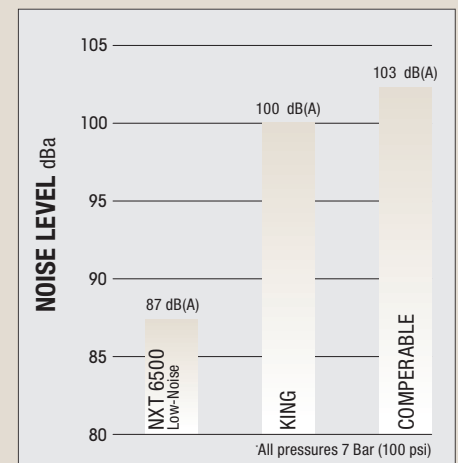

Selecting the Right Graco Supply System

How to choose the right pump for your material

Use these charts to select the pump that's right for your material

- 1) Select your required outlet pressure
- 2) Select your flow rate
- 3) Choose a Graco Supply System based on where these points intersect

CheckMate Pumps - (Medium to High Viscosity)

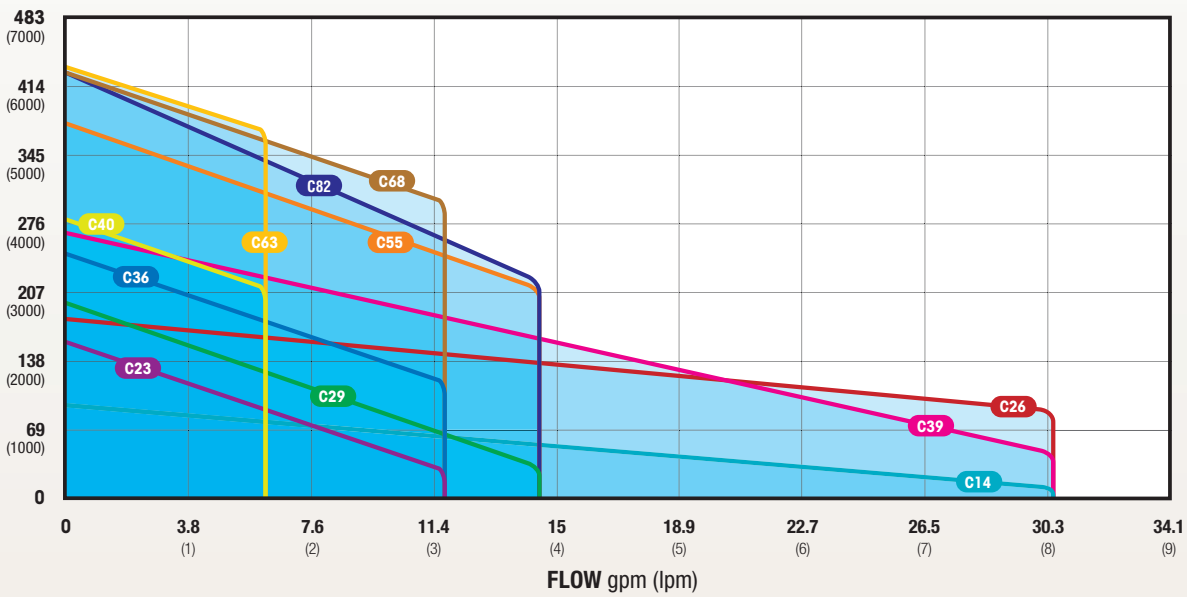

Dura-Flo Pumps - (Low to Medium Viscosity)

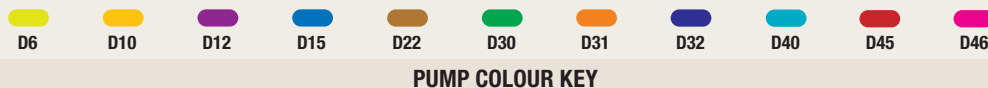
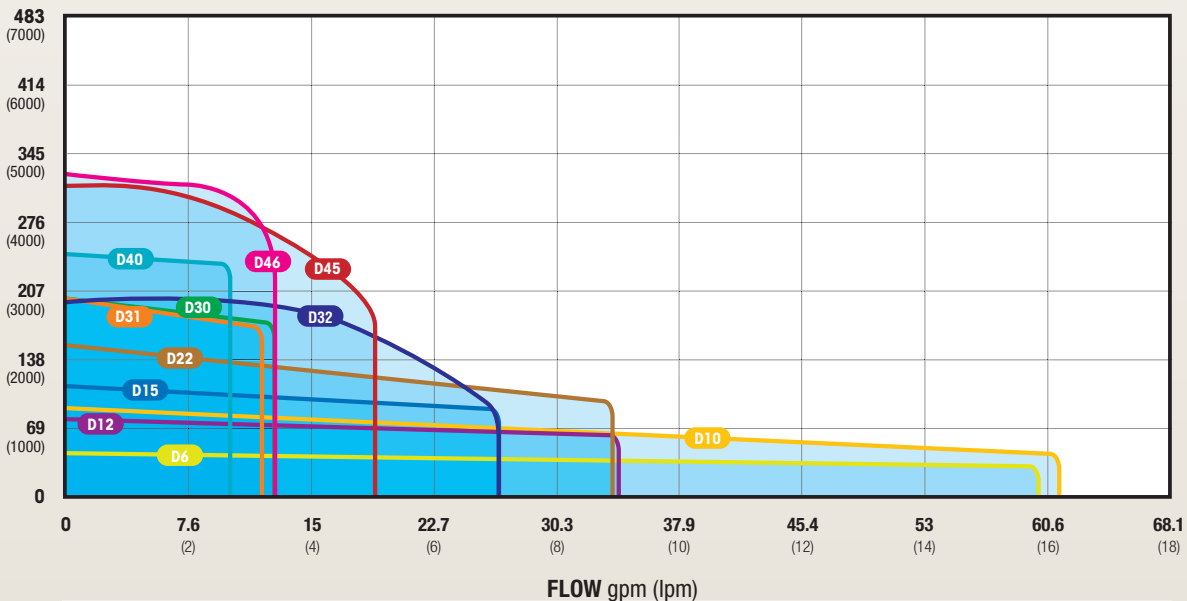

Reliable. Easy to Use. Easy to Service.

Check-Mate Pump – for medium to high-viscosity materials

NEW Xtreme Coupler

- Quick-disconnect coupler for easy maintenance

Replaceable Outlet Fitting

- Reduces repair costs

Piston Valve with Floating Piston Seal

- For maximum pressure balance over a range of material viscosities

Replaceable Seat

- Minimizes service costs

Floating Priming Plate

- Provides uniform flow

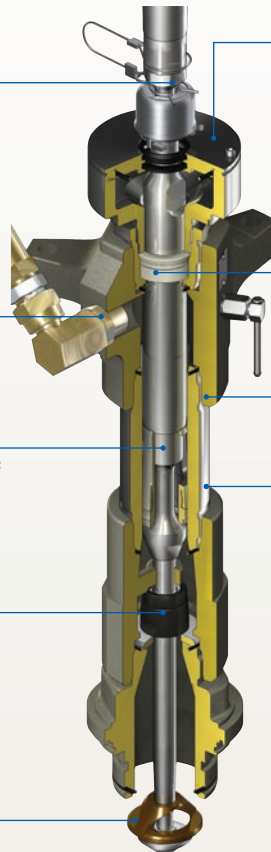

NEW Optional Enclosed Wet Cup

- Prevents seal contamination and allows recirculation
- Reduces maintenance and extends seal life

NEW Cartridge Throat Packings

- Allows for easy servicing without removing from ram

Cast Outlet and Inlet Housing

- Improves structural integrity

Hard Part Coatings

- Standard Severe Duty coating on rods and cylinder maximizes wear life
- NEW optional MaxLife coating triples pump life over standard offering

Dura-Flo Pump – for low to medium-viscosity materials

Quick-Disconnect Coupler

Reduces maintenance time

Manually Adjustable Wet Cup

Extends packing life by tightening packing nut

Cartridge Packings

Easily removable cartridge holds packings and allows for quick repairs

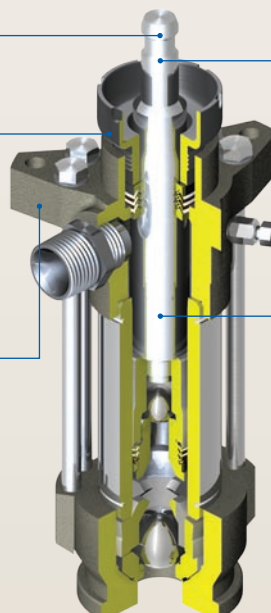

Stainless Steel Chrome Rod

Process provides over three times the life of chrome SST rods

High-Volume Piston

Improves flow for higher viscosity coatings

Pump Configurators and Specifications

Use Graco's numbering system

Graco's numbering system helps you simplify the ordering process. Just follow the diagrams below to select the parts you want. You'll have your order built easily and accurately in no time.

Check-Mate Pumps

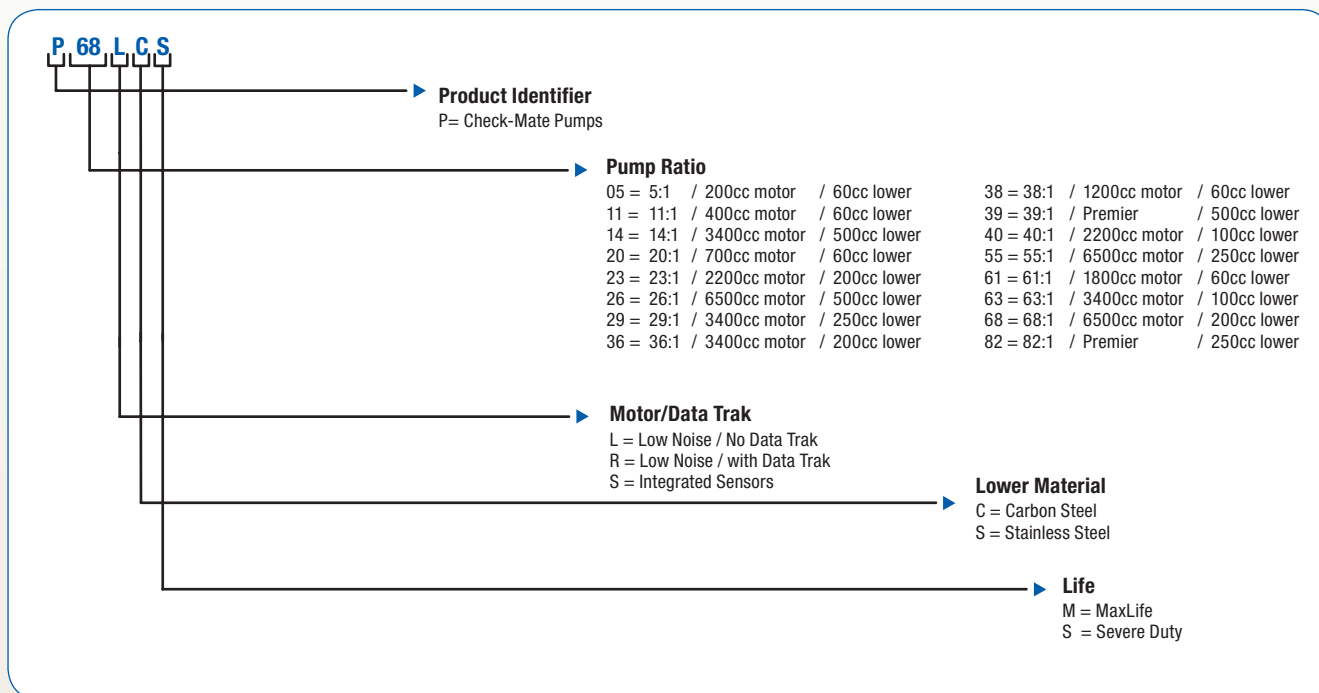

Dura-Flo Pumps

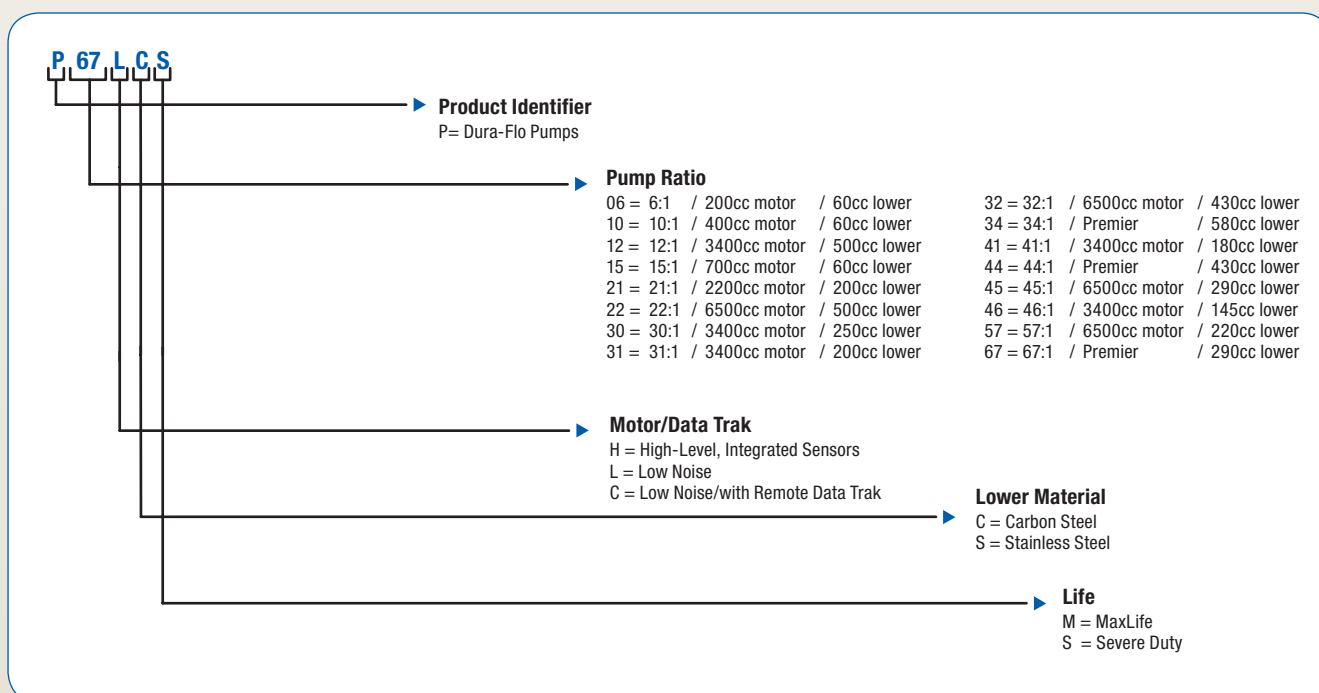

Check-Mate and Dura-Flo Pumps

All Check-Mate and Dura-Flo pumps have Ultra-High Molecular Weight Polyethylene (UHMWPE) and PTFE or leather packings. For urethanes and some silicones, an optional all-PTFE packing kit is available.

Check-Mate Loweres

Pump	LPM @60 CPM	Pump Ratio	Air Motor	BAR	CS	SST
C5	3,8	5:1 60cc	NXT200	34	Yes	Yes
C11	3,8	11:1 60cc	NXT400	75	Yes	Yes
C20	3,8	20:1 60cc	NXT700	140	Yes	Yes
C38	3,8	38:1 60cc	NXT1200	260	Yes	Yes
C61	3,8	61:1 60cc	NXT1800	420	Yes	Yes
C40	6,4	40:1 100cc	NXT2200	280	Yes	No
C63	6,4	63:1 100cc	NXT3400	435	Yes	No
C23	11,3	23:1 200cc	NXT2200	160	Yes	Yes
C36	11,3	36:1 200cc	NXT3400	250	Yes	Yes
C68	11,3	68:1 200cc	NXT6500	425	Yes	Yes
C29	14,3	29:1 250cc	NXT3400	200	Yes	Yes
C55	14,3	55:1 250cc	NXT6500	380	Yes	Yes
C82	14,3	82:1 250cc	Premier	425	Yes	Yes
C14	30,2	14:1 500cc	NXT3400	100	Yes	Yes
C26	30,2	26:1 500cc	NXT6500	180	Yes	Yes
C39	30,2	39:1 500cc	Premier	270	Yes	Yes

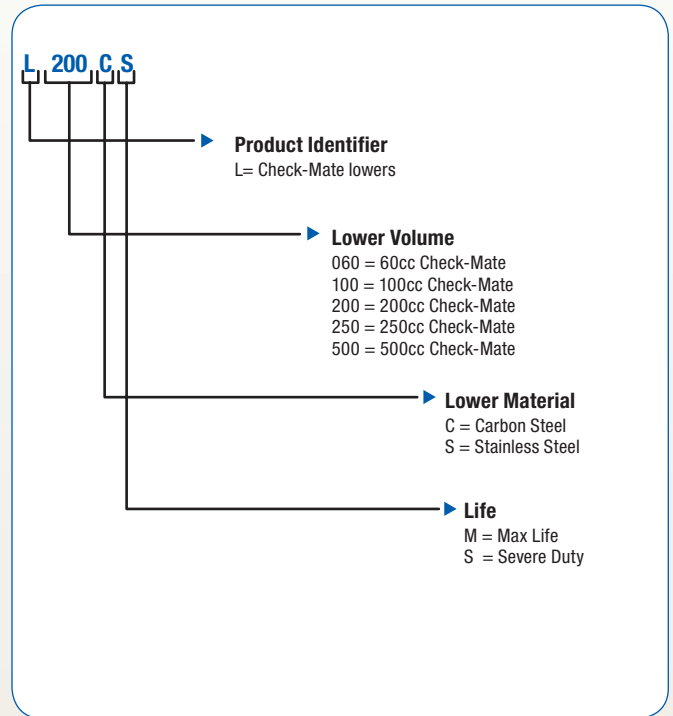

Dura-Flo Loweres

Pump	LPM @60 CPM	Pump Ratio	Air Motor	BAR	CS	SST
D31	8,7	31:1 145cc	NXT2200	215	Yes	No
D46	8,7	46:1 145cc	NXT3400	320	Yes	No
D21	12,8	21:1 220cc	NXT2200	145	Yes	Yes
D30	12,8	30:1 220cc	NXT3400	210	Yes	Yes
D57	12,8	57:1 220cc	NXT6500	395	Yes	Yes
D67	18,1	67:1 290cc	Premier	460	Yes	No
D15	26,1	15:1 430cc	NXT3400	105	Yes	No
D32	26,1	32:1 430cc	NXT6500	220	Yes	Yes
D44	26,1	44:1 430cc	Premier	305	Yes	Yes
D12	34,8	12:1 580cc	NXT3400	82	Yes	Yes
D22	34,8	22:1 580cc	NXT6500	150	Yes	Yes
D34	34,8	34:1 580cc	Premier	235	Yes	Yes
D10	59,8	10:1 1000cc	NXT6500	70	Yes	Yes

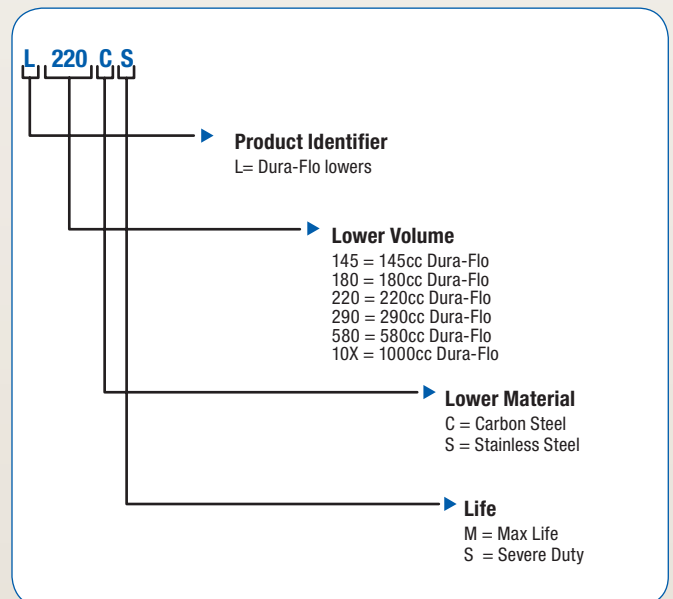

Selecting the Right Graco Supply System

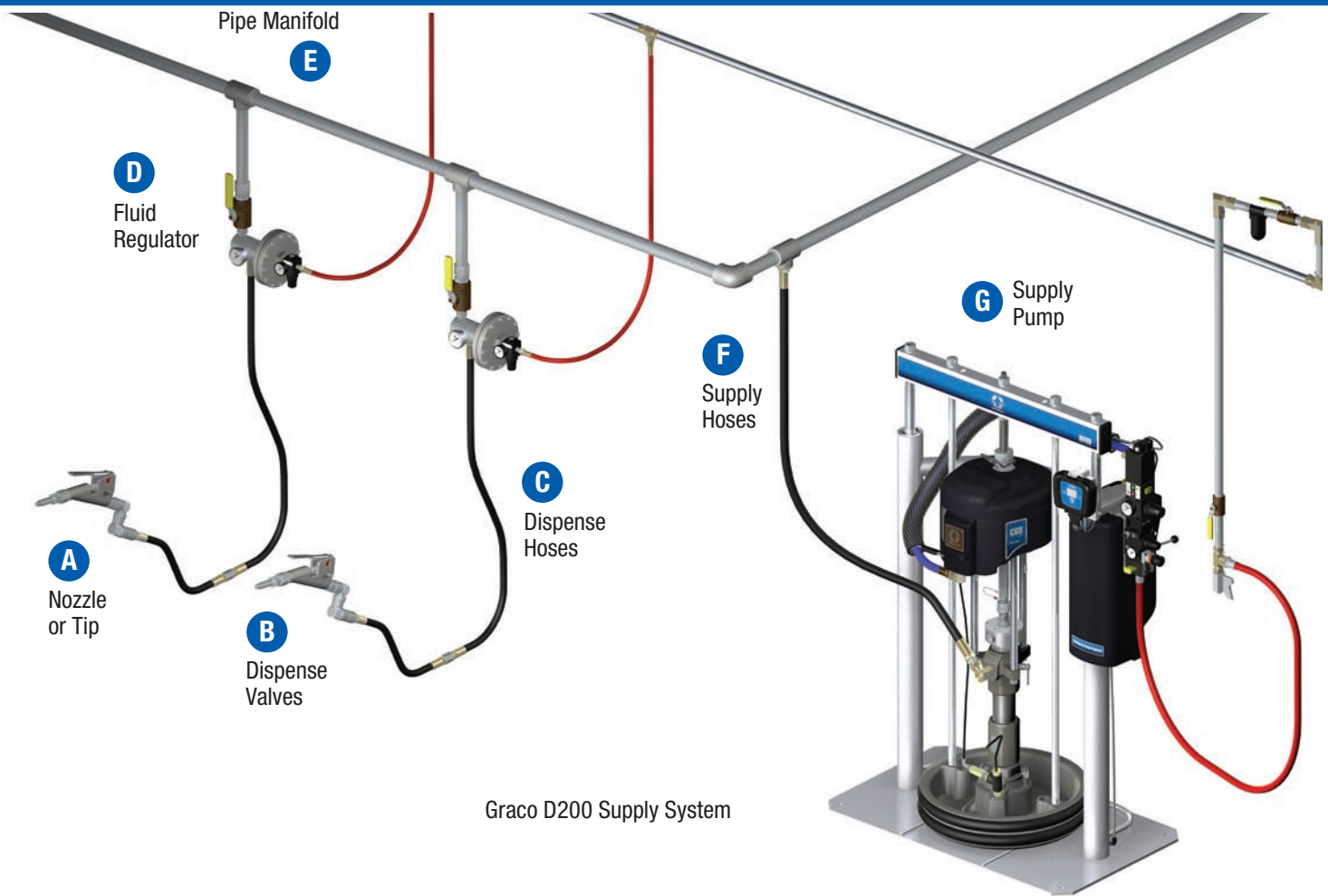

Graco D200 Supply System

Other factors to consider when choosing a supply system

	A	B	C	D	E	F	G
Major Components	Nozzle or Tip	Dispense Valves	Dispense Hoses	Fluid Regulators	Pipe Manifold	Supply Hoses	Supply Pumps
Selection Factors	Size, shape and type of fluid flow pattern	<ul style="list-style-type: none"> Usage <ul style="list-style-type: none"> - Manual - Automatic - Robotic - Shot Pressure Volume 	<ul style="list-style-type: none"> Viscosity Volume Length Pressure Flexibility Chemical compatibility 	<ul style="list-style-type: none"> Viscosity Pressure Volume Chemical compatibility 	<ul style="list-style-type: none"> Volume Pressure Location Drops Chemical compatibility 	<ul style="list-style-type: none"> Viscosity Volume Length Pressure Chemical compatibility 	<ul style="list-style-type: none"> Container Size Viscosity Pump Location Chemical compatibility
Equipment Options	<ul style="list-style-type: none"> Nozzles Tips Extensions Brushes 	<ul style="list-style-type: none"> Mechanical gun Pneumatic gun Nozzle <ul style="list-style-type: none"> - Extrusion - Spray - Length - Orifice 	<ul style="list-style-type: none"> Steel, SST Pipe, JIC Flexible hoses <ul style="list-style-type: none"> - PTFE - Buna - Nylon - Moisture-Lok 	<ul style="list-style-type: none"> Mastic regulator Pressure compensating valve 	<ul style="list-style-type: none"> Steel SST Pipe Tubing Sizes 	<ul style="list-style-type: none"> Steel, SST Pipe, JIC Flexible hoses <ul style="list-style-type: none"> - PTFE - Buna - Nylon - Moisture-Lok 	<ul style="list-style-type: none"> Priming piston Double ball Ram Mount Single or dual wipers Drum empty options Auto Crossover

Ordering Information



Accessories

Common Accessories

C59518	Pump Outlet Check Valve Kit (includes elbow, check valve, and union)
222780	Floor Stand
C59547	High Pressure Filter (includes 415 Bar (6000 psi), 30 mesh filter and two pressure gauges)
C07063	Ball Valve - 3/4-in npt, 310 Bar (4500 psi)
C07048	Ball Valve - 1/2-in npt, 400 Bar (5800 psi)
223689	Plastic Shield - 20L (10-pack)
222792	Plastic Shield - 200L (10-pack)

Outlet Check Kits

257377	Used on stainless steel Check-Mate 60 and 100 Displacement Pumps
255452	Used on carbon steel Check-Mate 100 Displacement Pumps
255453	Used on carbon steel Check-Mate 200 and 250 Displacement Pumps
255454	Used on stainless steel Check-Mate 200 and 250 Displacement Pumps
255455	Used on carbon steel Check-Mate 500 Displacement Pumps
255456	Used on stainless steel Check-Mate 500 Displacement Pumps

D200 Series Accessories

255477	Drum Stop Kit
255627	Drum Roller Kit
C32463	Saddle Clamps (D200s only)
918395	Heavy-Duty Drum Clamp Kit (D200s only)
918397	Clamshell Drum Holder Kit (D200s only)
255469	Low/Empty Sensor Kit
255675	Pneumatic Crossover Kit - 3-in ram
255676	Pneumatic Crossover Kit - 6.5-in ram
255691	200L (55 gal) Platen Cover
255703	Enclosed Wet Cup Recirculation Kit
255650	Air Controls

DataTrak and Electric Tandem Accessories

257635	Remote DataTrak Kit, VAC - S20
257636	Remote DataTrak Kit, VDC - S20
255704	Remote DataTrak VAC Kit - D200 and D60
255705	Remote DataTrak VAC Kit - D200s
255757	Remote DataTrak VDC Kit - D200 and D60
255758	Remote DataTrak VDC Kit - D200s
255689	Low/empty Sensor Kit - D200s
255706	Tandem A-side VAC Kit - D200 and D60
255708	Tandem B-side Kit - D200 and D60
255759	Tandem A-side VDC Kit - D200 and D60
255760	Tandem A-side VDC Kit - D200s
255707	Tandem A-side VAC Kit - D200s
255709	Tandem B-side Kit - D200s
255675	Pneumatic Crossover Kit - D200
255676	Pneumatic Crossover Kit - D200s
257632	Pneumatic Crossover Kit - D60
257633	Pneumatic Crossover Kit - S20
255469	Low/empty Sensor Kit - D200 and D60
257634	Low/empty Sensor Kit - S20
255468	Tandem Light Tower Kit
255467	DataTrak Light Tower Kit
255457	Tandem Depressurization Kit
255458	Tandem Depressurization Kit - Stainless
255415	Remote DataTrak Module
255336	Tandem Display Module
257915	Fluid Control Module - Tandem Ram
121226	CAN cable (0.4 m)
121227	CAN cable (0.6 m)
121228	CAN cable (15 m)

Check-Mate and Dura-Flo Lowers



Check-Mate Lowers

Part #	Lower Material	Coating	Available Seal Kits							Enclosed
			Enclosed Wet cup	Throat	Piston	Intake	Complete	PTFE complete		
L060SS	Stainless Steel	Severe duty	None	255523	255533	256865	256866	None	255559	
L060SM	Stainless Steel	MaxLife	255618	257558	255533	256868	256867	None	255559	
L060CS	Carbon Steel	Severe duty	None	255523	255533	255539	255507	255507	255696	
L060CM	Carbon Steel	MaxLife	255618	255524	255533	255540	255508	255692	255696	
L100SS	Stainless Steel	Severe duty	None	255523	255533	256865	256866	None	255559	
L100SM	Stainless Steel	MaxLife	255618	257558	255533	256868	256867	None	255559	
L100CS	Carbon Steel	Severe duty	None	255523	255533	255539	255507	255692	255696	
L100CM	Carbon Steel	MaxLife	255618	255524	255533	255540	255508	255692	255696	
L200SS	Stainless Steel	Severe duty	None	255526	255535	255542	255511	255693	255700	
L200SM	Stainless Steel	MaxLife	255619	255527	255535	255623	255512	255693	255700	
L200CS	Carbon Steel	Severe duty	None	255525	255534	255541	255509	255693	255697	
L200CM	Carbon Steel	MaxLife	255619	255527	255534	255622	255510	255693	255697	
L250SS	Stainless Steel	Severe duty	None	255529	255537	255545	255515	255694	255701	
L250SM	Stainless Steel	Maxlife	255620	255530	255537	255546	255516	255694	255701	
L250CS	Carbon Steel	Severe duty	None	255528	255536	255543	255513	255694	255698	
L250CM	Carbon Steel	Maxlife	255620	255530	255536	255544	255514	255694	255698	
L500SS	Stainless Steel	Severe duty	None	255531	255538	255549	255519	255695	255702	
L500SM	Stainless Steel	Maxlife	255621	255532	255538	255550	255520	255695	255702	
L500CS	Carbon Steel	Severe duty	None	255531	255538	255547	255517	255695	255699	
L500CM	Carbon Steel	Maxlife	255621	255532	255538	255548	255518	255695	255699	

Dura-Flo Lowers

Part #	Lower Material	Coating	Enclosed Seal Kit
L145SS	Stainless Steel	Severe duty	237609
L180SS	Stainless Steel	Severe duty	237608
L220SS	Stainless Steel	Severe duty	237710
L290SS	Stainless Steel	Severe duty	237713
L430CS	Carbon Steel	Severe duty	222845
L430SS	Stainless Steel	Severe duty	222845
L430SM	Stainless Steel	MaxLife	253744
L580CS	Carbon Steel	Severe duty	222875
L580SS	Stainless Steel	Severe duty	222875
L580SM	Stainless Steel	MaxLife	253745



ABOUT GRACO

Founded in 1926, Graco is a world leader in fluid handling systems and components. Graco products move, measure, control, dispense and apply a wide range of fluids and viscous materials used in vehicle lubrication, commercial and industrial settings.

The company's success is based on its unwavering commitment to technical excellence, world-class manufacturing and unparalleled customer service. Working closely with qualified distributors, Graco offers systems, products and technology that set the quality standard in a wide range of fluid handling solutions. Graco provides equipment for spray finishing, protective coating, paint circulation, lubrication, and dispensing sealants and adhesives, along with power application equipment for the contractor industry. Graco's ongoing investment in fluid management and control will continue to provide innovative solutions to a diverse global market.

GRACO LOCATIONS

CONTACT

MAILING ADDRESS

P.O. Box 1441
Minneapolis, MN 55440-1441
Tel: 612.623.6000
Fax: 612.623.6777

AMERICAS

MINNESOTA

Worldwide Headquarters
Graco Inc.
88-11th Avenue N.E.
Minneapolis, MN 55413

EUROPE

BELGIUM

European Headquarters
Graco N.V.
Industrieterrein-Oude Bunders
Slakweidestraat 31
3630 Maasmechelen,
Belgium
Tel: 32.89.770.700
Fax: 32.89.770.777

ASIA PACIFIC

JAPAN

Graco K.K.
1-27-12 Hayabuchi
Tsuzuki-ku
Yokohama City, Japan 2240025
Tel: 81.45.593.7300
Fax: 81.45.593.7301

ASIA PACIFIC

CHINA

Graco Hong Kong Ltd.
Representative Office
Room 118 1st Floor
No.2 Xin Yuan Building
No.509 Cao Bao Road
Shanghai, P.R. China 200233
Tel: 86.21.649.50088
Fax: 86.21.649.50077

ASIA PACIFIC

KOREA

Graco Korea Inc.
Choheung Bank Building
4th Floor #1599
Gwanyang-Dong, Dongan-Ku,
Anyang-Si, Gyunggi-Do,
Korea 431-060
Tel: 82(Korea).31.476.9400
Fax: 82(Korea).31.476.9801

All written and visual data contained in this document are based on the latest product information available at the time of publication.
Graco reserves the right to make changes at any time without notice.

Graco is certified ISO 9001.

Europe
+32 89 770 700
FAX +32 89 770 777
WWW.GRACO.BE